

# GASSY GOSSIP

AUGUST 2021



**INMEMORIAM**



**GASCOYNE FOOD COUNCIL**



**UPCOMING EVENTS**

# TABLE OF CONTENTS



## 4 COUNCIL NEWS & DATES

Here you will find news about the Shire straight from your CEO along with Council meeting dates.



## 21 IN MEMORIAM

Vale Ross Collins.

## 23



## BLAST FROM THE PAST

Explores the archives on past news and events.



## 25 GJ CRAFT GROUP

Interested in joining the Gascoyne Junction Craft Group? Check out the details here.



## 27 GASCOYNE FOOD COUNCIL

Outback to Ocean



## 29 LOVE YOUR LIBRARY

Library Lowdown

33



### GJSCHOOL NEWSLETTER

Learn what the local school children have been up to.



### COOKS CORNER

Recipes chosen just for you at home

42



### GUS THE GARDEN GNOME

Gus the Garden Gnome awaits to answer your gardening questions.



### BIRTHDAYS

Happy birthday to you all.



### GASSIFIEDS

Advertisements, new arrivals, birthdays and more.

53



### SMOKO TIME

Take a break and enjoy the puzzles and word games.

56



### KIDS CORNER

Puzzles and Games to keep the kids entertained.

59



### UPCOMING EVENTS

Here you will find all the important dates to jot down in your diary.

## Ordinary Council Meeting Dates

Friday 5th February

Wednesday 24th March

Wednesday 21st April

Wednesday 19th May

Wednesday 24th June

Wednesday 21st July

Wednesday 18th August

Wednesday 22nd September

Wednesday 20th October

Wednesday 17th November

Thursday 16th December

Council meetings commence at 8:30am in the Shire Council Chambers located at 4 Scott Street, Gascoyne Junction.

All ratepayers and residents are welcome to attend the council meetings and participate in the Public Question Time session which is held at the beginning of each Council Meeting.



# COUNCIL NEWS

## CEO Update

This month has been relatively busy with a host of administrative tasks associated with the end of one financial year and the beginning of another.

The Shire Auditors, William Buck, have had their representatives on site carrying out a range of audit tasks which are designed to check, review and test our procedures, policies and output over the previous year. We have not yet received the management letter; however, from conversations with the Auditors it appears there are no significant issues that raised a red flag. At this stage we are waiting for the draft management interim audit report to be issued, and hope this can be presented to Council by the August meeting.

At the last Regional Road Group Meeting it was identified that our Group did not have its own Procedures and Guidelines as required by the State Road Use Agreement. I volunteered to produce these and present them back to meeting in November. These are now complete and are with Ernie Reynolds for him to review and make comment prior to seeking our neighbour's comments. Whilst on the subject of Ernie Reynolds, Ernie advised that he had resigned from his position after 47 years of service; I would like to publically acknowledge Ernie's valuable contribution to our region over such a period of time - THANK-YOU ERNIE.

The Landor / Dalgety Sealing will be complete by the time of this Council Meeting. Although no Councillor will complain about the rain; it has caused significant operational challenges with people continuing to drive on 'Closed Roads' and causing significant damage to our assets. I have sought legal advice on the remedies available but at this stage they are convoluted and not very practicable to implement. I have written to the Minister for road safety and Police, Paul Papalia, seeking a meeting with him to discuss this issue and perhaps find a legislative approach where we can charge drivers a significant amount in order to discourage this behaviour.

## Corporate Services Update

So much has happened in 20/21 from the development of new community and infrastructure projects, to planning the construction of a new staff house, to creating the foundations of our tourism strategic plan, to being inundated with unprecedented levels of rainfall and bidding farewell to old staff and welcoming new staff to our team – 20/21 has been a very busy year!

Budgets continue to be the flavour of the month and are still high on our priority list leading into the July Council meeting. Travis from RSM has been working with the management team in finalising our draft document and working towards presenting a balanced budget for adoption in August.



## Community Resource Centre Update

June has been a busy month at the CRC with an influx of visitors to the Shire. We have received so much positive feedback of our beautiful town and how well cared for it is. Training has been undertaken by our staff updating our training with key stakeholders including Services Australia, Australia Post and the WA State Library.

On June 23 the CRC hosted the Gascoyne Junction Biggest Morning Tea. With a smorgasbord of amazing treats, it was wonderful to see the community come together and raise \$415 for such a wonderful cause.

Ainsley, attended a meeting of the Gascoyne DHAC at the beginning of the month which has providing a regular medical service to Gascoyne Junction as its top priority. Discussions are still underway in relation to having a clinic here. At the moment the main difficulty is the shortage of doctors across the state due to border closures, but with an increase in capacity things will progress further. In the meantime they are working on things in the background in relation to systems and equipment that will be required.

The CRC will be introducing a new Federal Government initiative in August called Be Connected which helps to educate Australians to reduce digital illiteracy. A series of lunch and learn sessions will be held at the CRC on a range of topics including spotting scams, safe online shopping and banking, connecting with others and helpful apps for your smartphone. Through this program we will also be able to use digital technologies to record local history from the perspective of our residents.

We have been in discussions to introduce a Library Management System for our local library. This will help with reporting, but most importantly will enable us to offer all residents of the Shire access to the library catalogue and to borrow remotely. It will also allow us to curate a local history collection.

A second meeting of the Visit Upper Gascoyne was held, with key projects identified for tourism across the Shire. The Tourism and Community Development Officer is working on a Tourism Action Plan to put in place which will have a first draft for the next meeting in September. A tourism advertisement for the Shire is currently running in June, July and August in the Seniors newspaper to which we have had a great initial responses, with people popping out to see what we have on offer.

### **Manager of Works and Services**

I would like to thank my colleagues for an enormous effort in delivering the works programme and projects that we managed to complete in such a hectic and wet financial year. Unfortunately we have some projects uncompleted due to the continuous rain and labour shortage including the new tourist stop and 6km of bitumen on Carnarvon Mullewa Road. These projects will be completed in the first half of the new financial year.

### **Town Crew:**

The town crew have had their hands full with keeping up with the weeding of parks, gardens and roadsides. Insurance repair work on various buildings and assets to repair damage from the February storms including fencing, paving and water damaged buildings has also been undertaken. We have also had contractors replace corroded veranda poles on Lot 39 Gregory Street, repair gyprock in Lot 52 Hatch Street and the decking on the CRC veranda.

### **Maintenance Graders:**

Our maintenance graders have finally managed to sink their teeth into actual maintenance grading for the first time this year. All year we have been chasing our tails repairing flood damage, rain damage and wheel ruts caused by people driving on closed roads. Unfortunately it didn't last long as we have to revert to repairing wheel ruts once again caused by people ignoring closed roads and wet weather during the school holidays. Once again this has distracted us from what we should be doing and cost the shire significantly.

### **Construction Crew:**

The construction crew have been carrying out repairs as mentioned while we wait for the new budget and works program to be adopted. If our proposed program is approved we will continue preparing for a further 7km of bitumen on the Carnarvon Mullewa Road and complete the remaining bitumen from our 20/21 schedule at the same time.

### **Equipment:**

The new grader camp has arrived and the final minor alterations are being made before it is put to work. We have sent our Bruce Rock side tipper to Geraldton to have the spring hangers and hydraulic ram mounting blocks replaced. We managed to nurse the trailer through until we had a break in works to carry out the repairs. Our mechanic Shane Pridham also used the quiet period to complete some minor repairs to various equipment and plant.

Next week we will advertise the sale of one of our 140M graders and padfoot rollers. We will then use the WALGA Preferred Supplier portal to procure replacement machines.

# COUNCIL UPDATE....

## FLOOD DAMAGE REINSTATEMENT REPORT



**SHIRE OF UPPER GASCOYNE – AGRN908 FLOOD DAMAGE REINSTATEMENT  
MONTHLY PROGRESS REPORT – July 2021 (PACKAGE 1)**

Contractor	QEM Group	Package Start Date:	19 Sept 2020
		Forecast Completion Date:	Nov / Dec 2021
<b>Works this period (July 2021)</b>		<b>Works next period (Aug 2021)</b>	
<p><b>Mt Augustus Woodlands Rd</b> Complete the bulk of the remaining works on this road. One minor defect remaining to be completed at the western end of the road.</p> <p><b>Cobra Mt Augustus Rd</b> Continue the works on this road comprising removal of silt, reforming and resheeting and reinstatement of drain lines.</p> <p><b>Bingegaroo Rd</b> Continue works on this road completing the majority of the works including reforming, removal of silt and reinstatement of drain lines.</p>		<p><b>Mt Augustus Woodlands Rd</b> Complete all remaining works.</p> <p><b>Cobra Mt Augustus Rd</b> Complete all remaining works primarily between Cattle Pool and Mt Augustus homestead.</p> <p><b>Bingegaroo Rd</b> Complete all remaining works on the southern end of the road comprising mainly removal of silt, reforming of the formation and reinstatement of drain lines.</p> <p><b>Cobra Gifford Creek Rd</b> Commence works on this road working from Gifford Creek homestead to Cobra homestead.</p>	
<b>Status of Roads</b>			
		<b>This Month</b>	<b>Last Period</b>
<b>Overall Package</b>		<b>76%</b>	<b>69%</b>
Bingegaroo Rd		79%	0%
Cobra Gifford Creek Rd		Not yet commenced	
Cobra Mt Augustus Rd		57%	5%
Dooley Downs Rd		Not yet commenced	
Edmund Gifford Creek Rd		Not yet commenced	
Landor Mt Clere Rd		100%	100%
Dalgety Downs Landor Rd		Not yet commenced	
Landor Meekatharra Rd		100%	100%

Landor Mt Augustus Rd	100%	100%
Lyndon Minnie Creek Rd	Not yet commenced	
Meekatharra Mt Clere Rd	100%	100%
Mount Augustus Rd	100%	100%
Mount Augustus Woodlands Rd	99%	84%
Mooloo Downs Access Rd	Not yet commenced	
Pingandy Rd	Not yet commenced	
Pingandy Homestead Access Rd	Not yet commenced	
Potts Rd	Not yet commenced	
Walzburg Rd	100%	100%
Wanna Rd	Not yet commenced	
<b>Discussion Items</b>		
Water / Materials	Refer attached resources report	
Camp		





*Cobra Mt Augustus Rd Silc 30.25 - Defect*



*Cobra Mt Augustus Rd Silc 30.25 - Completed.*



*Cobra Mt Augustus Rd – Current works.*



*Cobra Mt Augustus Rd – Current works.*

**SHIRE OF UPPER GASCOYNE – AGRN908 FLOOD DAMAGE REINSTATEMENT  
 MONTHLY PROGRESS REPORT – July 2021 (PACKAGE 2)**

Contractor	THEM Earthmoving	Package Start Date:	8 Nov 2020
		Forecast Completion Date:	Early 2022
<b>Works this period (July 2021)</b>		<b>Works next period (August 2021)</b>	
<p><b>Carnarvon Mullewa Rd</b> Completed all remaining works on this road.</p> <p><b>Hatch St</b> Completed all remaining works on this road.</p> <p><b>Killili Rd</b> Completed all remaining works on this road.</p> <p><b>Ullawarra Rd</b> Continued work on this road working from approx. 15km north of Gascoyne Junction townsite south. Approx. 4 days has been lost due to weather delays.</p>		<p><b>Ullawarra Rd</b> Commence works from the northern end of the road working south towards Minnie Creek Rd. Works mainly comprise reforming and resheeting, removal of silt, reinstatement of drain lines and reinstatement of unsealed floodways.</p>	
<b>Status of Roads</b>			
	<b>This Month</b>	<b>Last Period</b>	
<b>Overall Package</b>	<b>39%</b>	<b>32%</b>	
Carey Downs Road	Not yet commenced		
Carnarvon Mullewa Road	100%	97%	
Cobra Dairy Creek Road	Not yet commenced		
Dalgety Downs Glenburgh Road	100%	100%	
Dalgety Downs Landor Road	100%	100%	
Erong Road	100%	100%	
Eudamullah Road	Not yet commenced		
Gilroyd Road	Not yet commenced		
Gregory Street	Transferred to AGRN951 scope		

Hatch Street	100%	50%
Killili Road	100%	88%
Lyons River Road	Not yet commenced	
Minnie Creek Road	Not yet commenced	
Mooloo Downs Access Road	Not yet commenced	
Newton Drive	100%	100%
Pimbee Road	Not yet commenced	
Riverside Drive	100%	100%
Rubbish Tip Road	100%	100%
Scott Street	100%	100%
Ullawarra Road	17%	0%
Viveash Way	100%	100%
Weedarrah Road	Not yet commenced	
<b>Discussion Items</b>		
Water / Materials	Refer attached resources report	
Camp	Camp has been shifted north along Ullawarra Rd near the Minnie Creek Rd.	



*Ullawarra Rd Slk 3.5- Completed.*



*Ullawarra Rd Slk 6.7 - Completed.*



*Ullawarra Rd S1k 8.00 - Completed.*



*Ullawarra Rd S1k 8.4 - Completed.*

**SHIRE OF UPPER GASCOYNE – DALGETY DOWNS LANDOR RD UPGRADE TO SEAL  
 PROJECT COMPLETION REPORT**

Contractor	Dean Contracting	Start Date:	March 2021
		Completion Date:	July 2021
<b>Scope of work</b>			
<ul style="list-style-type: none"> <li>• Upgrade of approx. 13km of Dalgety Downs Landor Rd, 100m of Landor Mt Augustus Rd and 600m of Landor Meekatharra Rd from an unsealed standard to a sealed standard.</li> <li>• Dean Contracting's scope of work comprised:             <ul style="list-style-type: none"> <li>○ Earthworks</li> <li>○ Pavement</li> <li>○ Drainage – floodways and culverts</li> <li>○ Stock grid replacement</li> <li>○ Roadside furniture (signs, guideposts)</li> </ul> </li> <li>• Boral's scope of work comprised:             <ul style="list-style-type: none"> <li>○ Design and supply of bitumen spray seal</li> </ul> </li> <li>• Total cost was estimated at approx. \$3.9M</li> <li>• Works were funded 47% via AGRN908 DRFAWA (flood damage) and 53% via the Heavy Vehicle Safety and Productivity Program (HVSPP).</li> </ul>			
<b>Current Status</b>			
<ul style="list-style-type: none"> <li>• Dean Contracting's scope is complete.</li> <li>• Boral's scope is complete.</li> <li>• Both contractors have a 12-month defect liability period</li> <li>• Supporting financial documentation is being prepared and collated in preparation for submission to DFES for reimbursement of DRFAWA funds and MRWA for reimbursement of HVSPP funds.</li> <li>• Total final cost of works is still being determined but is expected to be approx. similar to the budgeted amount.</li> </ul>			

SEALING WORKS – SITE PHOTOS



*Dalgely Downs - Landor Rd SLK 71.39 - 001.JPG - Photo showing area prepared ready for sealing.*



*Dalgely Downs - Landor Rd SLK 73.87 - 001.JPG - Photo showing Prime seal in floodway.*



*Dalgely Downs - Landor Rd SLK 76.89 - 002.JPG - Sealing First coat of 14mm stone.*





*Dalgety Downs - Landor Rd SLK 76.90 - 003.JPG - Intersection Sealing.*



*Dalgety Downs - Landor Rd SLK 76.90 - 004.JPG - Intersection Sealing.*



*Dalgety Downs - Landor Rd SLK 76.90 - 005.JPG - Intersection Sealing.*

# RESPECT OUR ROADS



## CLOSED MEANS CLOSED FOR LOCALS & VISITORS ALIKE

The Shire of Upper Gascoyne encourages visitors to experience our beautiful attractions and soak up everything the real Australian outback has to offer.

We are a large shire of 46,602 square kilometres with approximately 1,950kms of unsealed roads and our team takes great pride in looking after these roads to ensure everyone enjoys a safe comfortable drive.

Sometimes we need to close roads to traffic due to wet conditions. While this may be an inconvenience in the short term, we do it for your own safety and to ensure safe roads all year round for visitors and locals. It is important to check local weather conditions and forecasts before travelling on unsealed roads; this information can be found at [www.bom.gov.au](http://www.bom.gov.au). Severe damage can occur to roads when people drive on closed or wet roads. It is not only extremely dangerous but can be costly for our shire to repair. Please consider those that live in the Shire of Upper Gascoyne and depend on these roads all year.

Please do not drive on our roads if they are closed. Penalties may apply to those who choose to ignore "Road Closed" signs and the shire may choose to prosecute offenders for the cost of repairs. If you have an accident or injury on a closed road, you may not be covered by your insurance company. This applies to locals and visitors alike.

We make every effort to minimise delays and appreciate your patience and assistance when roads are closed.

For further information and up to date road reports please visit our website:

[www.uppergascoyne.wa.gov.au/roadreport](http://www.uppergascoyne.wa.gov.au/roadreport)

T: (08) 9943 0988

F: SUG6705

Shire Office Hours: Mon-Thu 8.30am to 4.30pm    Fri 8.30am to 3.00pm



Landor Burringurrah Rd May 2016: driving on wet roads, estimated repair costs were \$45,000.00

# Shire of Upper Gascoyne

## Request for Tender



## Disposal of Bomag Padfoot Roller

### RFT - 01\_21/22

The Shire of Upper Gascoyne invites tenders to be received until 4pm 19th August 2021 for the purchase and removal of a 2006 Bomag BW216D-4 padfoot vibratory roller (VIN No. 101582621102)

The Deadline for Tenders to be submitted is Thursday, 19th August 2021 at 4.00pm WST.

Tender documents can be obtained by emailing [cso@uppergascoyne.wa.gov.au](mailto:cso@uppergascoyne.wa.gov.au) or available at the Shire Office, Scott Street, Gascoyne Junction, WA, 6705.

Tenders should be contained in a sealed envelope clearly marked with the Tender name and number and lodged at the Shire Office, Scott Street or posted to 4 Scott Street, Gascoyne Junction, WA 6705.

Tenders can also be submitted electronically via email to [ceo@uppergascoyne.wa.gov.au](mailto:ceo@uppergascoyne.wa.gov.au). Tenders submitted by facsimile will not be accepted.

Sealed envelope clearly marked with the Tender name and number and lodged at the Shire Office, Scott Street or posted to 4 Scott Street, Gascoyne Junction, WA 6705.

The Shire has a reserve trade in price set by an independent third party.

Canvassing of Councillors or staff will disqualify Tenderers.

Jarrold Walker  
Acting Chief Executive Officer

**For enquiries, please call the Shire office on (08) 9943 0988**

# 2021 COUNCIL ELECTIONS

**16th October 2021**

## 3 COUNCILLOR POSITIONS UP FOR NOMINATION

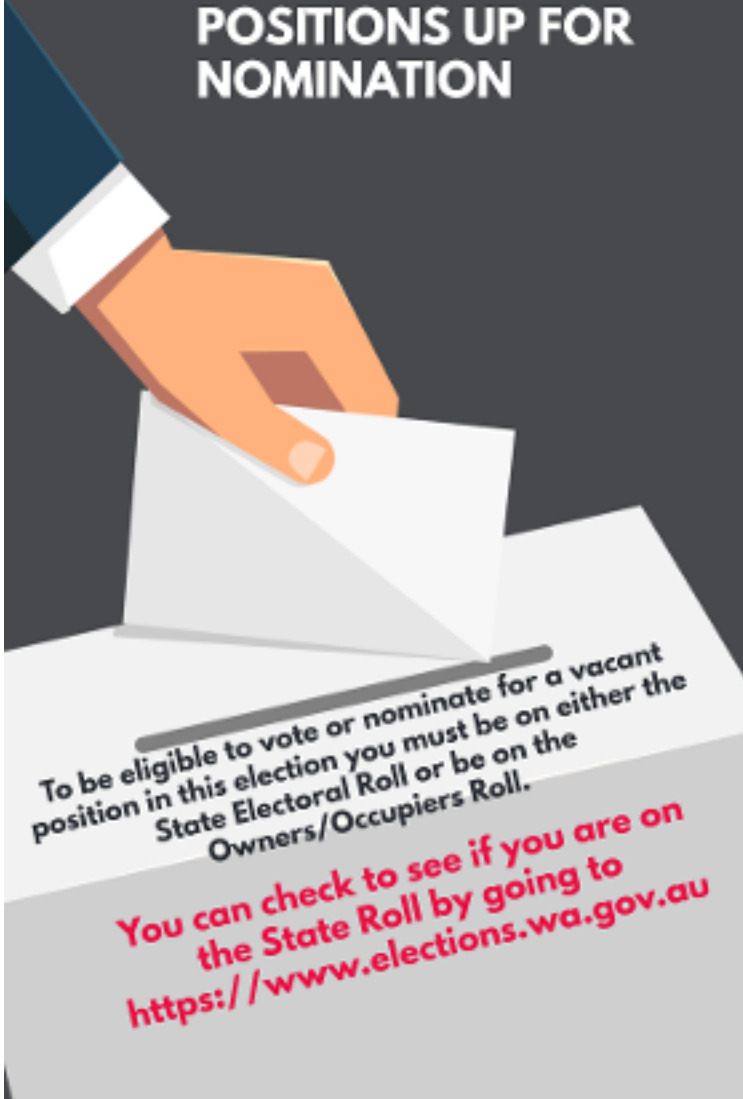

To be eligible to vote or nominate for a vacant position in this election you must be on either the State Electoral Roll or be on the Owners/Occupiers Roll.

You can check to see if you are on the State Roll by going to <https://www.elections.wa.gov.au>

If you are not registered on the applicable voting rolls you can make application to the CEO for the Shire of Upper Gascoyne to be added to the Owners / Occupiers Roll. This means you may live in another area but own or rent / lease land in the Local Government District or it could mean that you reside in the Local Government Area. This applies to Mining Tenements, Pastoral Leases, Commercial / Industrial / Residential Land.

Applications for both the residents and owner/occupiers roll close at  
5:00pm on Friday 27 August 2021

For those intending to nominate for a Councillor position the first date you can nominate on the  
2nd of September 2021.

This has to be done on a prescribed form and must be lodged with the returning officer.

The nomination period is open for 8 days and closes at 4.00pm on the 9th of September 2021.

All candidates must complete an online candidate induction prior to nominating for election so they are fully aware of what to expect as an elected member and the rules related to campaigning. This will be available on the Department of Local Government, Sport and Cultural Industries web site. Candidates must also make a deposit of \$80 which is repaid if the candidate receives more than 5% of the vote.

All are encouraged to be a part of this process whether this be by nominating to be a Councillor or voting for your preferred candidate.



## **ROSS COLLINS**

On behalf of the Shire of Upper Gascoyne and broader community we offer our most sincere condolences to Ross' family and friends.

Ross has spent most of his life as a pastoralist whom held the lease of Glenburgh Station situated in the Upper Gascoyne Shire. He is the 3rd generation of the Collins family, which the property was named Glenburgh by Ross's grandfather, Charles Collins in 1887.

Ross was elected as a shire councillor in 1975 and served the shire for five years until stepping down. He ran again for council in 1985 and was re-elected. Ross became the shire President in 1990 and remained so until he retired in 2015.

In 2004 Ross was honoured to receive an Order of Australia (OAM) for his service to the community of Upper Gascoyne.

Ross served on the council for 35 years with 25 years as the President for the Shire of Upper Gascoyne. Ross was made a Freeman of the shire in 2015.

# Name the Visitors Stop



Despite some delays due to the wet weather the Visitors Stop at the Gascoyne Junction is beginning to come together.

We would formally like to open up to community consultation the naming of the Visitors Stop. All name submissions are to be received at the Community Resource Centre by August 31 2021.

Submissions can be placed into the submissions box in person at the Community Resource Centre or emailed to [crc@uppergascoyne.wa.gov.au](mailto:crc@uppergascoyne.wa.gov.au)

These names will be considered and voted on by the Shire of Upper Gascoyne Council Members.



## GASCOYNE JUNCTION - VISITORS STOP



# BLAST FROM THE PAST

THIS SEGMENT OF THE GOSSIP EXPLORES PAST ARTICLES ON NEWS AND EVENTS. THIS ARTICLE WAS ORIGINALLY PUBLISHED IN THE NORTHERN GUARDIAN ON 23 JULY 1997

JANUARY NORTHERN GUARDIAN 23 JUL 97

## Races success in 90th year

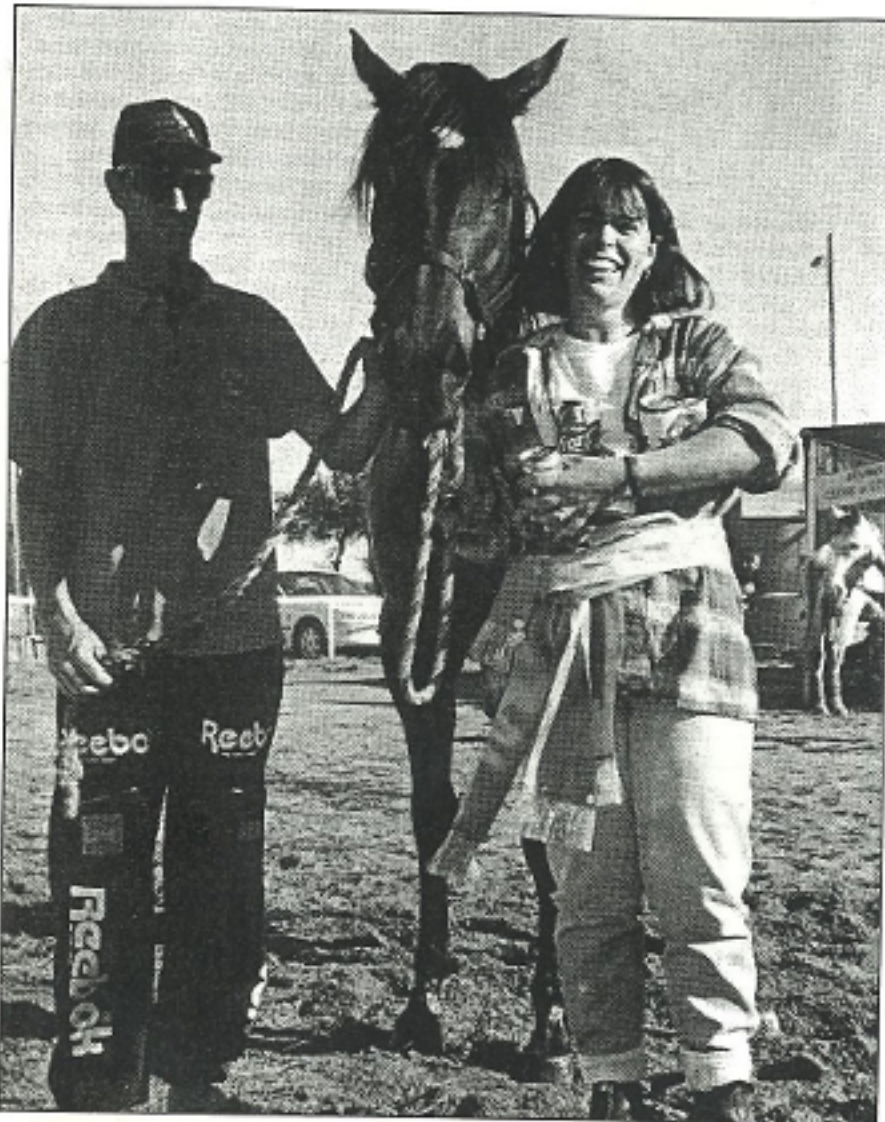

DAVID and Debbie Dicks with two-time winner Mr Tibbs.

SINCE 1907, the tiny town of Gascoyne Junction has attracted crowds to the annual Junction Races, and this year was no exception.

The population of the tiny town east of Carnarvon swelled from 39 to 1000 as the racegoers attended the Junction's biggest yearly event.

This year marked the 50th anniversary of the races in its present location.

Junction Race Club secretary Jane McTaggart said the turnout was impressive and she had received much positive feedback about the weekend.

While she was aware that many believed it would be the last year the event would be held, Ms McTaggart said if nominations were received for the Junction Race Club committee, the event would continue.

"I think everyone would want to keep it going. We just need a strong committee," she said.

About 350 people camped out on Friday

night to watch an open-air bush concert.

On Saturday morning, the racing began and six races were held.

"The number of nominations was disappointing in a couple of races but generally it was pretty good," Ms McTaggart said.

The gymkhana on Sunday was also a success, bringing many nominations.

And while the visitors headed home, a big clean-up near the race track began on Monday.

Ms McTaggart said the clear skies and big attendances were two highlights of the weekend.

Carnarvon Police Sen. Sgt John Young said there were a few minor incidents but the weekend was reasonably trouble-free.

U21-545 WEEK 3



**Do you have an unmarked grave on your property?**

**Do you know of one within the Shire of Upper Gascoyne?**

**The Shire wants to help preserve these graves by offering an Outback Grave Marker.**

**Whether you know a little of the story or nothing at all contact the Tourism & Community Development Officer on 08 9943 0988 or email [tcdo@uppergascoyne.wa.gov.au](mailto:tcdo@uppergascoyne.wa.gov.au)**

**If you can provide as much information about each site including location this will help in getting plaques arranged.**





## **GASCOYNE JUNCTION CRAFT GROUP 2021 CALENDAR**

13<sup>th</sup> & 14<sup>th</sup> February Untutored & AGM **(cancelled)**

27<sup>th</sup> & 28<sup>th</sup> March Untutored **(cancelled)**

18<sup>th</sup> & 19<sup>th</sup> April Dongara Autumn Craft Round Up  
**(cancelled)**

22<sup>nd</sup> & 23<sup>rd</sup> May Untutored & AGM

19<sup>th</sup> & 20<sup>th</sup> June Copper Foiling Workshop

24<sup>th</sup> & 25<sup>th</sup> July Resin Dipping Outside Tutored Workshop  
(provided we can get a tutor)

14<sup>th</sup> & 15<sup>th</sup> August Out Back Wives overnight bag

18<sup>th</sup> & 19<sup>th</sup> September Untutored

30<sup>th</sup> & 31<sup>st</sup> October Mosaic Workshop

November 27<sup>th</sup> & 28<sup>th</sup> Christmas Craft

For any queries, please contact the Secretary Tina Matthews

E: [junctioncraft@gmail.com](mailto:junctioncraft@gmail.com)

P: 9943 0531

*YEARLY MEMBERSHIP \$20 UNTUTORED WEEKENDS \$10  
WORKSHOPS \$50 with craft supplied materials  
OUTSIDE TUTORED WORKSHOPS \$50 + materials if required*

# Roll up for WA

## COVID-19 Vaccination

Western Australia is one of the safest places in the world. To help protect our lifestyle, COVID-19 vaccinations are now rolling out across the state.

All Western Australian adults will be able to receive the COVID-19 vaccine in metropolitan Perth and at regional clinics when they are eligible.

Find out when and where to go to receive a COVID-19 vaccination by visiting the [online eligibility checker](#). You can also sign up to be notified when it's your turn to be vaccinated.

To stay updated on the vaccine rollout, find trusted resources, and answers to any questions you may have, visit the WA Government's [Roll up for WA](#) website.

Advice in different languages is available online at <https://www.health.gov.au/initiatives-and-programs/covid-19-vaccines/covid-19-vaccine-information-in>

For more information about the vaccination program visit: [healthywa.wa.gov.au/COVID19vaccine](https://healthywa.wa.gov.au/COVID19vaccine) or call 13 COVID (13 268 43).

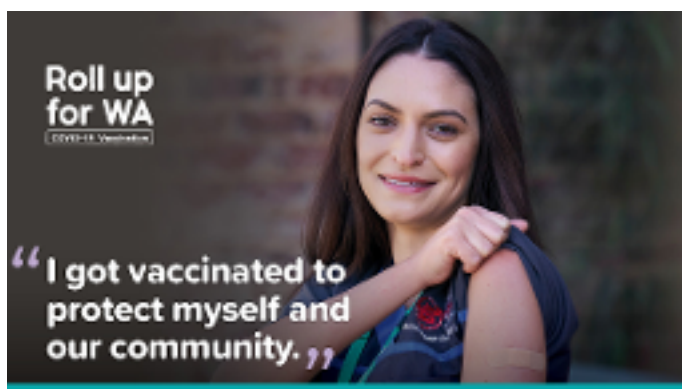

  
*Gascoyne*  
FOOD FESTIVAL

# Outback to Ocean

**FRIDAY 13 AUGUST | 6.30PM TO 10.30PM**

**UNDER THE STARS @ GASCOYNE JUNCTION**

Where the Outback meets Ocean, come together in Gascoyne Junction under an Outback Starlit Sky to enjoy delicious Gascoyne Fresh produce, a song or two and real outback hospitality. Begin the evening with a Gascoyne Plate entrée highlighting the variety of locally sourced ingredients. For main, whilst in the heart of cattle country enjoy surf and TURF, the backbone of industry for the region with a touch of surf reflecting our location at the Junction of Western Australia's two longest rivers that flow to the ocean nearby. Finally, conclude the evening with your own sample dessert plate with each tantalising selection to sparkle like the stars in the sky above.

**\$120 PER PERSON - INCLUDES BEER, WINE & BUBBLES  
SURF & TURF THREE COURSE DINNER BY ALYS MCKEOUGH**

**[WWW.GASCOYNEFOODFESTIVAL.COM.AU](http://WWW.GASCOYNEFOODFESTIVAL.COM.AU)**

**CARNARVON VISITOR CENTRE | [INFO@CARNARVON.ORG.AU](mailto:INFO@CARNARVON.ORG.AU) | (08) 9941 1146**

# Star Gazing at the Junction

Saturday August 14

Gascoyne Junction Pavilion

5.30pm to 8.30pm

Join us for an evening of star gazing with the team from the Perth Observatory and their telescopes to take in the night sky.

Guest speakers on Astro Photography will also be in attendance.

A camp dinner will be supplied on the evening.

Tickets for this event are FREE and are available through the Gascoyne Junction CRC.

Limited Numbers so BE QUICK.

08 9943 0988

[crc@uppergascoyne.wa.gov.au](mailto:crc@uppergascoyne.wa.gov.au)



PERTH  
OBSERVATORY

## BOOKS OF THE MONTH

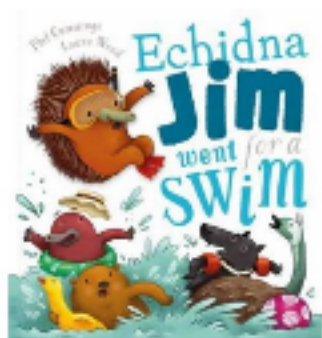

### **ECHIDNA JIM WENT FOR A SWIM BY PHIL CUMMINGS & LAURA WOOD**

Bubbling, bouncing, surfing and splashing, everyone was having a wonderful time at the beach. Until...

Echidna Jim went for a swim!

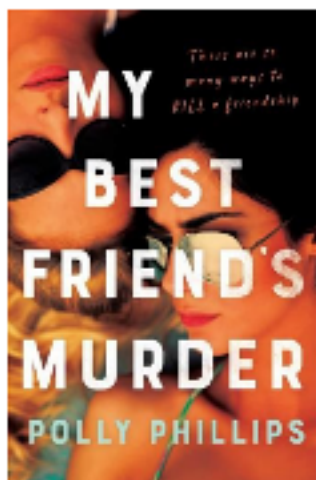

### **MY BEST FRIEND'S MURDER BY POLLY PHILLIPS**

There are so many ways to kill a friendship...

Bec and Izzy have been best friends their whole lives. They have been through a lot together – from the death of Bec's mother to the birth of Izzy's daughter. But there's a darker side to their friendship, and once it has been exposed, there is no turning back.

So when Izzy's body is found, Bec knows that if the police decide to look for a killer, she will be the prime suspect. Because those closest to you are the ones who can hurt you the most. The Rumour meets The Holiday in this compulsive thriller with a toxic friendship at its heart that keeps you in the dark until the final breathless pages.

# NINETY

That is how many new titles arrived at the Gascoyne Junction Library this month. DVDs, Biographies, Audio Books, Childrens Books, Fiction and Non Fiction await. The Library is FREE to join. Make sure you take a look next time you are visiting the CRC.

## DVDs

1. Angel of Mine
2. The Hunt
3. It's a Sin
4. Monster Hunter.
5. Treadstone: Season 1

## AUDIO

6. Fast Ice by Clive Cussler & Graham Brown
7. The Four Winds by Kristin Hannah
8. How beautiful we were by Imbolo Mbue
9. The Red Book by James Patterson & David Ellis

## LARGE PRINT FICTION

10. Daughters of Darkness by Sally Spencer
11. Good Company: a novel by Cynthia D'Aprix Sweeney
12. Half Life: A novel by Jillian Cantor
13. The Liar's Dictionary: a novel by Eley Williams
14. Jane n love: a novel by Rachel Givney
15. Whereabouts by Jhumpa Lahiri

## FICTION

16. The Bounty by Janet Evanovich and Steve Hamilton
17. Detransition, baby by Torrey Peters
18. A Fatal Secret by Faith Martin
19. Find Your First by Linwood Barclay
20. The Geometry of Holding Hands by Alexander McCall Smith
21. The Lady has a Past by Amanda Quick
22. Lean Fall Stand by Jon McGregor
23. The Light of the Midnight Stars by Rena Rossner
24. Lovebirds by Amanda Hampson
25. The Missing Sister by Lucinda Riley
26. The Other Half of You by Michael Mohammed Ahmad
27. Other Women by Cathy Kelly
28. The Palm Beach Murders by James Patterson with James O Born, Tim Arnold & Duane Swierczynski



# NEW TITLES

## FICTION

- 29. The Perfect Lie by Jo Spain
- 30. Protector by Conn Iggulden
- 31. Take Me Home by Karly Lane
- 32. Twenty by James Grippando
- 33. A Valley Dream by Anna Jacobs

## NON FICTION

- 34. The 16:8 Intermittent Fasting Lifestyle Plan by Jaime Rose Chambers
- 35. Air Fryer Express: 60 delicious recipes for dinners, snacks and school lunches by George Georgievski
- 36. Argyle: the impossible story of Australian Diamonds by Stuart Kells
- 37. The Art of Being a Tourist at Home: expand your world without leaving your hometown by Jenny Herbert
- 38. BuildHer by Rebeka Morgan & Kribashini Hannon
- 39. The Complete Fishing Manual: tackle, baits & lures, species, techniques, where to fish by Henry Gillbey
- 40. Eat plants, be happy! by Caroline Griffiths & Vicki Valsamis
- 41. Enigma of the Dark: the case of the Claremont serial killer by Tim Clarke
- 42. Finding Freedom: Harry & Meghan: the making of a modern royal family by Omid Scobie & Carolyn Durand
- 43. I saw the dog: how language works by Alexandra Y Aikenvald
- 44. The kindness revolution: how we can restore hope, rebuild trust and inspire optimism by Hugh Mackay
- 45. The life of a spy: an education in truth, lies and power by Rod Barton
- 46. Mutineers: a true story of heroes and villains by Robert Hadler
- 47. No Fail Watercolour: the ultimate beginner's guide to painting with confidence by Mako
- 48. Secret & Special: the untold story of Z Special Unit in the Second World War by Will Davies
- 49. Sex, lies and question time by Kate Ellis
- 50. Sorry and beyond: healing the stolen generation by Brian Butler and John Bond
- 51. Ultimate Cycling Trips. World. by Andrew Bain
- 52. The women's doc: true stories from five decades delivering babies & making history by Carlone de Costa

## JUNIOR NON FICTION

- 53. Atlas of record breaking adventures Written by Emily Hawkins Illustrated by Lucy Letherland
- 54. Customs and Traditions of the Australian Defence Force by Allison Paterson
- 55. Do Animals Fall In Love? by Katharina von der Gathen and Anke Kuhl
- 56. Fantastic Beasts: the wonder of nature Foreword by Sir Ranulph Fiennes

## KIDS DVD's

- 57. Blue's Clues & You !
- 58. Bluey Vol 9 Queens and Other Stories

# FOR THE KIDS

## PICTURE BOOKS

59. Be a Tree! written by maria Gianferrari
60. Blue Floats Away Words by Travis Jonker
61. Book Hospital by Leigh Hodgkinson
62. The Boys by Lauren Ace and Jenny Lovlie
63. Day Break by Amy McGuire and Matt Chun
64. Early One Morning by Mem Fox & Christine Davenier
65. Ernie's Journey by David Woodland
66. Father Sky and Mother Earth by Dodgeroo
67. Happy Mother's Day written by real kids about their mums!
68. The House of Grass and Sky by Mary Lyn Ray
69. I don't want to be a big sister Written and Illustrated by Heath McKenzie
70. Love Giraffes Can't Dance by Giles Andreae and Guy Parker-Rees
71. Main Abija= My Grandad by Karen Rogers
72. Move that Mountain by Kate & Jol Temple
73. Norton and the Bear by Gabriel Evans
74. Our Little Kitchen by Jillian Tamaki
75. Penny and the Little Lost Puppy by Emily Sutton
76. The Poop Song by Eric Litwin
77. Shu Lin's Grandpa Story by Matt Goodfellow
78. Some Mum's by Nick Bland
79. Unicorns don't love rainbows by Emma Adams
80. What the Fluffy Bunny said to the Tiny Mouse Written by P Crumble
81. When the Wardrobe Dries Up by Kaye Baillie
82. Who is at the Zoo? by Sharon J Boyce
83. Your Life Matters by Chris Singleton

## JUNIOR FICTION

84. A Clue for Clara by Lian Tanner
85. Field Trip Fiasco by James Patterson and Martin Chatterton
86. The Great Escape Fartist by Magda Szubanski
87. Little Jiang by Shirly Marr
88. The Nerd Herd by Nathan Luff
89. The Pirate Captain's Cat by Philip Ardagh
90. Kondo & Kezumi visit Giant Island Written by David Goodner





Newsletter

30/07/2021

## PRINCIPAL'S POST

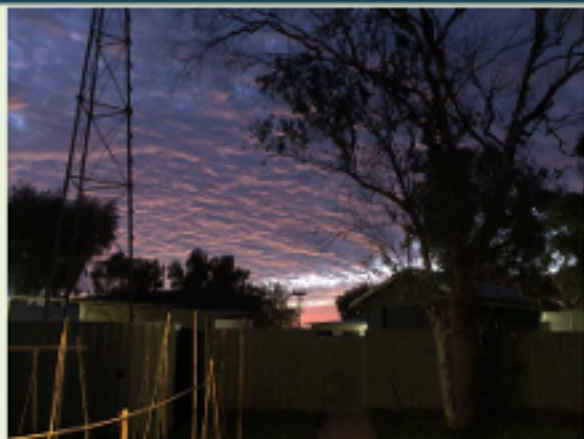

*Hello to parents, families, and the school community.*

Over the past term, we have continued our commitment to offering quality professional learning opportunities for staff.

Congratulations go to Miss Wilson, Miss Jodie and Miss Kenny who recently attended and passed the following weekend course: 'Provide a first aid response in an education and care setting'. Well done to all of you.

These three staff members have also undertaken professional learning in *Back to Front Maths*, which upskills them to teach and support the Maths program introduced last year at GJRCS.

Our School Council meets again on Monday 2<sup>nd</sup> August. Our council members are also undertaking some training to provide them with information to enable them to understand their roles and responsibilities as members and undertake the functions of a School Council.

Our Chairperson, Ainsley Hardie can be contacted at the Shire if there are any questions or concerns that you may wish to discuss. I am also available for support or just a chat whenever needed.

*Kind regards  
Jackie Miller, Principal*



## JOIN US FOR A BOOK WEEK PARADE

### Where?

Gascoyne Junction RCS Library

### When?

Friday 27th August, 12:00pm-1:00pm

### What?

**Dress up and join our Book Week Parade.**

This year the theme is *Old Worlds, New Worlds, Other Worlds.*

*The Book Week Parade will start at 12:00pm. Bring a plate and join us for a light lunch following the parade.*

*Visiting children can bring a change of clothes and join our students for play during lunch break from 12:30pm to 1:00pm.*

**We look forward to seeing you.**

## \$\$\$\$\$\$ QUIZ NIGHT \$\$\$\$\$\$ SCHOOL FUNDRAISER AMOUNT RAISED

*Sorry for the late update on monies raised from the quiz night held on the 1st of May. The Junction school raised \$652 to go towards school resources.*

*Thanks once again to all who attended; it was a great night and something we look forward to doing annually.*

## WINTER CARNIVAL & CROSS COUNTRY



The Year 5 and 6 students joined in with the Carnarvon teams for the Winter Carnival held late last term.

Bridie played soccer and Dustin played AFL. Thanks to Carnarvon Community College for making our students feel welcome on the day.

Dustin and Bridie also participated in the Cross-Country Event on the day prior to the Winter Carnival.

They did themselves proud, with Bridie finishing 2<sup>nd</sup> and Dustin 3<sup>rd</sup> in their races. What a great effort!

The results are shown below.



Year 3	Boys	1	Dennis Brockman	CCC	2	Girls	1	Giada Piliou	SW
		2	Rosam Humphries	CCC			2	Indigo McKenzie	SW
		3	Kashu Walsh	CCC			3	Wagdy Pappou	SW
Year 4	Boys	1	Nathan Deeken	CCC	1	Girls	1	Neel Jardi	SW
		2	Colin Henry	SM			2	Neil De Vos	CCC
		3	Clara Dallas	CCC			3	Caprina Dany	CCC
Year 5	Boys	1	Kevin Semmonds	SM	1	Girls	1	Jessica Dumenich	SW
		2	Tyler Lauer	SM			2	Giada Walker	SW
		3	Will Gray, B. Blue	CCC			3	Maria Redjo	CCC
Year 6	Boys	1	Edgar Mills-Milly	CCC	1	Girls	1	Elle Howson Smith	CCC
		2	John Murray	SM			2	Neel Jardi	CCC
		3	Dustin Walker	CC			3	Suzanne Chaplin	SW



## SPORTING SCHOOLS ATHLETICS TRAINING



On Thursday Tess from Stephen Michael Foundation came to school to teach us athletics and hopping and jumping and throwing. We threw with bean bags and balls plus vortexes.

By Juanita

On Thursday Tessa from the Stephen Michael Foundation came from Carnarvon to do some athletics. We did some jumping and hopping plus some throwing with a vortex.

By Bridie

On Thursday Tessa Daly came out from Carnarvon to Gascoyne Junction with the Stephen Michael Foundation to practise for the Athletics Carnival.

The first few drills we did were some obstacles like jumping over hurdles, crawling under them and also hopping into hoops that were far apart. Tessa also taught us how to throw straight.

My favourite bit was the relay race because we had to jump over hurdles and race through a ladder, and it was a timed event, so that's what made it really fun.

By Dustin

## THE THREE LITTLE PIGS

Our Kindy students, Andre and Richard listened to the Big Book story of Three Little Pigs. They gave a retell of the story then painted their favourite part. They couldn't decide on a favourite, so painted the pigs instead.



# PROTECTIVE BEHAVIOURS

Our students have been working through the Protective Behaviours Program which helps develop skills for life is a living skills and personal safety program. **The aim is to strengthen the resilience of children as they grow and develop.** It focuses on giving children life skills to protect themselves from abusive situations, and on teaching children to avoid a wide range of potentially unsafe situations. We have just finished Theme 1.

## THEME 1

***We all have the right to feel safe at all times***

- ❖ the concept of feelings
- ❖ expanding students' vocabulary on feelings words
- ❖ discussing meanings of feeling safe and unsafe
- ❖ understanding that we all have different feelings, and that it is OK to express our feelings
- ❖ developing the capacity to understand and self-regulate their emotions in ways that account for their own feelings and those of others
- ❖ exploring their own sense of self and the factors that contribute and influence their identities

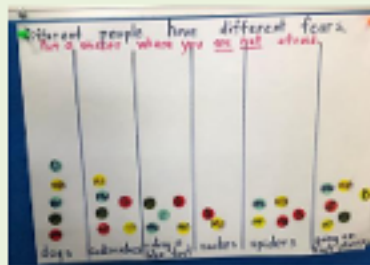

**PHOTOS:** Harley showed how he identified safe and unsafe situations. Juanita completed a survey on what people are **not afraid of** and discussed the results. Dustin categorised different situations into the four main categories that make up the Rights of the Child: The right to **Protection**, to **Speak Freely**, to be supported in all areas of their **Development** and the right to **Survival**.

## COMING EVENTS

02/08/21	School Council Meeting 5pm
02/08/21	School Psych visit (Laura)
03/08/21	Census visit school library (Caroline Lewis) 10:30am onwards
05/08/21	Sporting School's visit (Athletics)
09/08/21	Imaan (speech therapist) visit
14/08/21	Star Gazing
16/08/21-20/08/21	Science Week
19/08/21	Sporting School's visit (Athletics)
21/08/21-22/08/21	Junction Races
23/08/21-27/08/21	Book Week (Parade is on Friday 27 <sup>th</sup> )
25/08/21-26/08/21	Jackie out- Desert Network Meeting
27/08/21	Book Week Parade

PRESENTS

BE

CONNECTED

LUNCH & LEARN ALL THINGS DIGITAL  
1PM TO 2PM AT THE CRC FREE EVENT

### TUE AUG 3 CONNECTING WITH OTHERS

Its vital to stay in touch with friends and family. Learn how you can make video calls, send typed or instant messages, send photos and written updates with your friends.

### WED AUG 18 CAN YOU SPOT A SCAM

Australians aged 55+ lost over \$50 million to scammers in 2019. Join us for lunch and learn how to spot common scams, what to do and what not to do and where to go for help.

### WED SEP 01 SAFE ONLINE SHOPPING AND BANKING

For many Australian's a connected lifestyle includes the convenience of online shopping and banking, however, privacy and security concerns can stop those who aren't as confident online from enjoying the same experience.

### WED SEP 16 HELPFUL APPS FOR YOUR MOBILE PHONE

What is an app? Where do you find them and how do you download them? Find out all this and more.

BE CONNECTED

Be connected is an Australia wide initiative empowering all Australians to thrive in a digital world. We have online learning resources on offer to support you so you can develop digital skills and confidence. Join us at the Gascoyne Junction CRC for firendly help and advice.

# Getting set up for video calling

Here are some top tips for making video calls over the internet.

## What is video calling?

One of the great things about the internet is that it lets you make video calls, for free, at just about any time you want.

A video call is just like a phone call, but you can also see the face of the person, or people, you're speaking to.

## What you need

You probably already have everything you need to make video calls.

The key things you need are:

- A camera, or 'webcam', for capturing video.
- A microphone for talking into.
- Speakers for hearing the person you're calling.

All these things are built into most computing devices, including desktop computers, laptops, tablets and smartphones. Some desktops might not have web cameras, however. If this is the case, you can buy a separate webcam and plug it into your desktop computer.

You will also need the right application.



What you'll need to make video calls

# Getting set up for video calling

## Video calling applications

There are a number of video calling applications. Some of the best known are:

- Skype
- WhatsApp
- FaceTime



Each of these applications can be downloaded for free from official App stores. FaceTime and Skype actually come already installed on many devices.

When you video chat with someone, they have to be using the same application as you. If you're using Skype, you can't call someone using WhatsApp, for example.

## How much it costs

Most video calls are free. You can talk for as long as you want.

There are some exceptions. Skype, for example, lets you make voice calls from your computer to a normal phone line, but this is not free. Calling another person who's also using Skype is totally free, however.



**Most video calls are free!**

## Using the camera

The camera on your device is usually located just above the screen. To use it, just follow these guidelines:

- If you're calling from a computer, sit and use your laptop or desktop computer from a normal, comfortable typing position.
- With a smartphone or tablet, you hold it at a comfortable distance from your face. Usually you will be holding it tall-ways.



**Sit in a normal, comfortable position**

# Getting set up for video calling

## Using the microphone and speakers

When talking during a video chat, just speak normally. You don't need to shout.

The voice of the other person will come out through the speakers on your device.

If you have trouble hearing them, you can turn up the volume using the volume buttons on your device.



## Time to call

Lots of people use video calls, and it is now very easy to do. Usually you just choose a person's name from the contact list on your device and press the video call button. The other person's device will ring, and when they pick up you can start talking. It's that easy!





Do you have family recipe that you would love to share with us? Send it through to us at [crc@uppergascoyne.wa.gov.au](mailto:crc@uppergascoyne.wa.gov.au)

## STRAWBERRY AND RICOTTA CROSTINI

### Ingredients

10 baguette slices, sliced on an angle  
125g / 1 cup fresh ricotta  
125g / 2 cups fresh strawberries, quartered  
fresh mint  
balsamic vinegar  
salt and coarsely ground black pepper

### Method

1. Lightly toast the baguette slices and spread the fresh ricotta evenly between each slice
2. Divide the strawberries into quarters and place among the slices.
3. Garnish with mint before lightly drizzling the balsamic vinegar over each crostini
4. Finish with a sprinkle of salt and pepper





# Gus the Garden Guru is Back

Gus is a mischievous little gnome and has been missing from our pages. Never fear, we have tracked him down to share his wisdom about the garden with you all.

## Tips for getting to know your own garden

When was the last time you stopped to smell the roses in your own garden. Are you guilty of using it as a fast track in and out of the house.

Take some time this month to really get to know your garden

- See what insects are there, and around which plants
- Take close up photos of the bits that interest you
- Observe if there is any birdlife, and what type
- Look at what's active in the morning and different at night

Remember that your garden is a living thing, rather than just a space.

### COMING IN OCTOBER

The Shire of Upper Gascoyne will be taking part in the Great Aussie Backyard Bird Count. During the month of October residents will be asked to spend 20 minutes in their own backyard or a favourite space in the Shire and record the different species of birds you see. At the end of the month the data collected will give us a snapshot of what birdlife also call the Shire home.

## Ask Gus?

Have a gardening question that you need answering?

Send your questions to Ask Gus via email to the [crc@uppergascoyne.wa.gov.au](mailto:crc@uppergascoyne.wa.gov.au) and Gus will reply to you in the next edition of the Gassy Gossip



# Have you had any of these...

## ... for more than 4 weeks?

- Problems peeing
- Runny poo
- Unexplained weight loss
- An unusual pain, lump or swelling anywhere in your body
- Becoming more short of breath
- A persistent cough
- A new or changed spot on your skin

## ... once or more?

- Blood in your poo
- Coughing up blood
- Blood in your pee



If you have and you are over 40...

# Tell your doctor

The earlier cancer is found, the greater the chance of successful treatment.

Partner:



Government of **Western Australia**  
Department of **Health**



For more information visit [findcancerearly.com.au](http://findcancerearly.com.au) or call 13 11 20



THE  
*Gascoyne's*  
VERY OWN  
**MULTI-SPORT  
GAMES!**



**22 TO 24 OCTOBER 2021**



FOR MORE INFO VISIT: [WWW.EXMOUTH.WA.GOV.AU](http://WWW.EXMOUTH.WA.GOV.AU)

OR EMAIL: [gascoynegames@exmouth.wa.gov.au](mailto:gascoynegames@exmouth.wa.gov.au)



# Gascoyne Junction Community



## Footy Tipping

The split round saw some upsets on the field and in the tipping. The leaderboard at the top has been moving around.

Round 17 Winner: Ainsley

Round 18 Winner: Billie

Round 19 Winner: Sean

Round 20 Winner: Billie and Sean

With 7 rounds to go, this is getting very exciting.

Name	Results	Margin
Ian	115	528
Cherie	113	610
Sa	113	706
Jox	112	702
Max	109	570
Billie	108	530
Sean	108	654
Ainsley	106	738
Jeremy	102	631
Blanche	99	653
Clint	98	561
Frank	98	607
Jarrood	95	529
Anna	89	772
Jason	88	905
Thomas	86	765

## Junction Netball Team



After 14 rounds the Junction Netball team still remain undefeated. With two more rounds remaining before they head into finals the girls are currently leading the competition by ten points.

# Introduction to Yoga & Pilates Class

A beginner's class about  
the fundamentals of yoga & pilates



5:30 to 6:15 pm  
Each Wednesday  
Gascoyne Junction Pavilion  
\$10 per person

For bookings, contact  
Gascoyne Junction CRC  
08 9943 0988

Or Hee Jeong 0499 10 77 61



## **JRC BUSY BEE DATES**

**The Junction Race Club is asking the Gascoyne public to volunteer their time in helping prepare the JRC for our iconic 2021 race meeting on the following dates;**

**14/15 August - Busy Bee**

**20-22 August - JRC meeting**

**Any help would be appreciated, for more info call Hamish on 0401282562**

# JUNCTION PUB RACES MENU



## JUNCTION RACES LUNCH & DINNER SET MENU August 20 to 24

Choice of Two  
Courses  
\$55 per head

Prepared  
by  
Chef Omo



### ENTREE

Olive and Pickle Pot Herbs, Bread Rolls

### MAIN

#### BRAISED PORK BELLY

Pork Braised in Apple Cider Beer, Mash Potato, Vegetable, Apple Sauce

#### GRILLED SCOTCH FILLET

Marinated Scotch Fillet, Chips, Salad, Peppercorn Sauce, Garnish with Baby Spinach

#### NIGERIA GOAT PEPPER SOUP

Goat Pepper Soup, Jasmine Rice and Side Salad

#### STEAMED FISH

Aromatic Steamed Fish in Banana Leaf, Coconut Nut Nage Cruised, Asia Slaw

#### CHEF OMO CONFIT BUTTERNUT (V)

Confit Butternut, Wild Mushroom, Smoked Tomato Sauce, Winter Green

### DESSERT

#### MALVA PUDDING

South African Malva Pudding, Butternut Scotch Sauce & Ice Cream

### AFTER DINNER

Vanilla Ice Cream Walnut, Mint Leaf & Homemade Chocolate Sauce

To Book:  
E: [info@junctiontouristpark.com.au](mailto:info@junctiontouristpark.com.au)  
T: 08 9943 0868

# Artists - Look Here

## *Call for entries*

The Gascoyne Arts Awards will be held  
on Friday 22nd October 2021  
in Carnarvon.

Best overall artwork prize is \$10,000.

Contact [jennywalsh@wn.com.au](mailto:jennywalsh@wn.com.au) or  
Gascoyne Arts Society Facebook for  
details & entry form.





# Census

## The Census is on 10 August 2021

'Our Story. Our Future.' was created by proud Wiradjuri, Wotjobaluk, Yuin and Gumbaynggirr artist Luke Peerith and Makililgal people, Badu Island artist Naseli Tamwoy.



The Census counts every person and home in Australia. It helps to tell **our story** of who we are as a people.



Before Census night, you'll either get a letter with instructions on how to complete online or a paper form. You can start as soon as you get your instructions.

- Person 1  
Mum's name
- Person 2  
Dad's name
- Person 3  
Nan's name
- Person 4  
Uncle's name
- Person 5  
Baby's name
- Person 6  
Cousin's name

Make your community count. Include **everyone** who is staying in your home on Census night, such as Elders, babies and visitors.

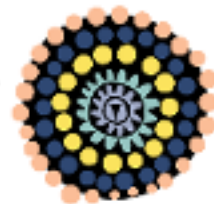

Your personal information isn't shared with other government agencies or anyone else.



Help is available – visit [www.census.abs.gov.au/indigenous](http://www.census.abs.gov.au/indigenous) or call 1800 512 441.



# Census

## What you need to know

"Our Story, Our Future" was created by proud Wiradjuri, Woiwobokuk, Yala and Gunbaiyiggin artist Luke Penwith and Makulligal people, Boigu Island artist Nasol Tamwey.



### The 2021 Census

The Census counts every person and home in Australia. It helps to tell our story of who we are as a people.

- The Census asks questions about our communities, who we are, where we live, and about people living and staying with us.
- People living in cities and regional areas will either get a letter with instructions on how to complete online, or a paper form. You can start as soon as you get instructions, if you know where you'll be on Census night, **Tuesday 10 August**.
- There will be Census staff in remote communities. They can come to your home and help you fill in your Census.
- It generally takes about 30 minutes to complete the Census. It might take longer for bigger households.

### Make your community count

The Census can help plan for community needs and our future. That's why it's important to include everyone who is staying in your home on Census night, such as Elders, babies and visitors.

- Having the right numbers means the right services can be provided for our community. For example, knowing the number of babies in a region can help plan funding for preschools or mums and bubs health programs.
- It's used to make decisions about schools and early learning, health clinics, housing, aged care, jobs, roads, language centres and community programs.

### Your personal information is safe

Your personal information is protected by law and isn't shared with anyone.

- You can't be identified by the information you share about yourself and your family in your Census.
- Need more information or assistance? Visit [www.census.abs.gov.au/indigenous](http://www.census.abs.gov.au/indigenous) or call 1800 512 441.

For more information, visit [www.census.abs.gov.au/indigenous](http://www.census.abs.gov.au/indigenous) or call 1800 512 441.



### AUGUST

- 1 Alys McKeough
- 18 Spags Burnett
- 18 Harry McKeough
- 20 Jodie Gibson
- 23 Theona Mitchell-Smith

### SEPTEMBER

- 9 Stanley Hammerquist
- 20 Jason Windie
- 28 Matthew Hammerquist
- 29 Donald Hammerquist

### OCTOBER

- 13 Jodie McTaggart
- 15 Wendy Hoseason-Smith
- 17 Ray Hoseason-Smith
- 17 Oscar Hammarquist
- 22 Richard Dowker
- 24 Ken Kempton
- 26 Melanie Hammarquist
- 30 Shiney
- 30 Paula Hammarquist



# GASSIFIEDS

TO ADVERTISE PLEASE CONTACT US  
CRC@UPPERGASCOYNE.WA.GOV.AU

Are you looking for a place to get your business, your event, or your items for sale in front of the residents of the Shire of Upper Gascoyne?

Its time to book an advertising space in the Gassy Gossip. Whether its for one month or year round this is the place to be seen.

Free advertising for community groups and not for profit organisations.

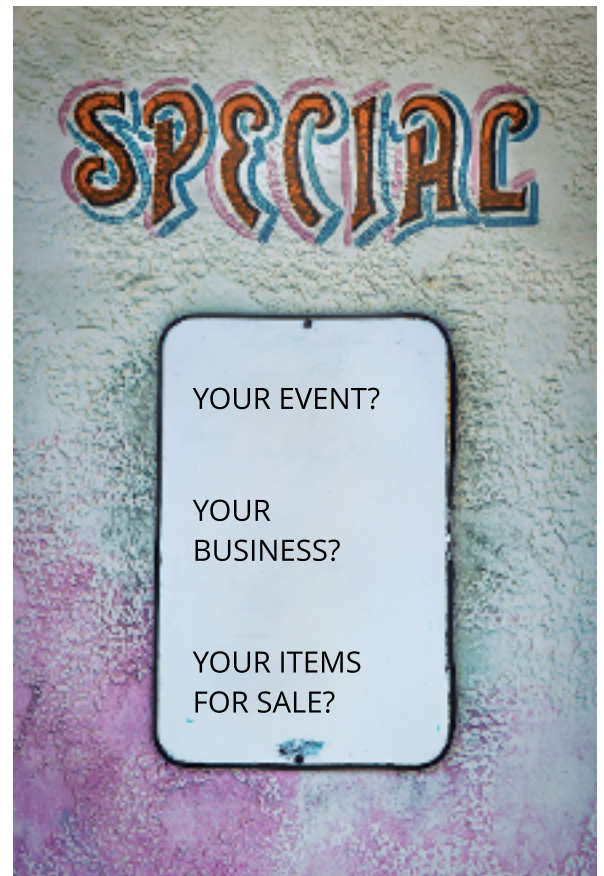

## WANT TO SEE YOUR BUSINESS IN THE GASSIFIEDS

### ADVERTISING RATES PER MONTH

A4 - \$41.20

A5 - \$25.75

A6 - \$20.60

Business Card Size - \$8.24

Contact the CRC on 9943 0988 or  
crc@uppergascoyne.wa.gov.au



# SMOKO TIME



## Space Crossword

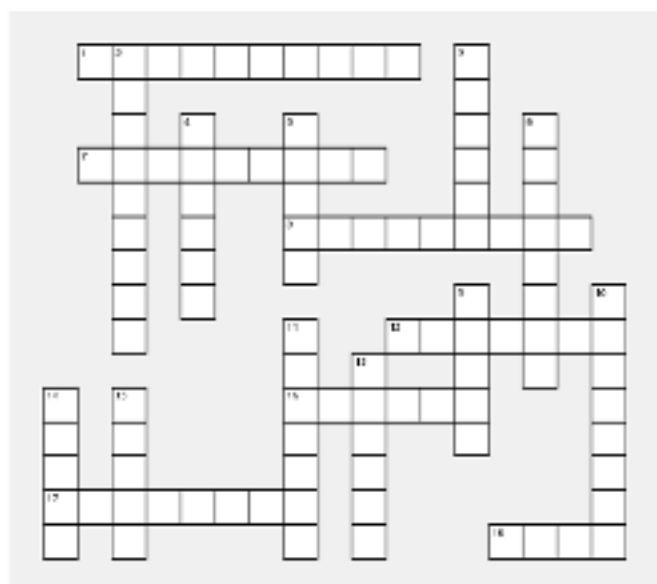

### ACROSS

- 1) Sky-at-night observer
- 7) Observatory instrument
- 8) Planet beyond Sol's grasp
- 12) Attractive force
- 16) Mars or Neptune, e.g.
- 17) All there is
- 18) Space Race goal

### DOWN

- 2) Exploding star
- 3) Solar halo
- 4) Falling star
- 5) Halley's \_\_\_\_\_
- 6) Body in a belt
- 9) Terra firma
- 10) Lightest element
- 11) Largest of the planets
- 13) Milky Way, e.g.
- 14) Evening star
- 15) Planet's path

Free Crossword Puzzles, Compliments of © Memory-Improvement-Tips.com

## Jupiter's Moons Word Search

E Y W P G A A K E Y L C W S S  
 O U B F N E B B E H T H A O I I  
 M S R A U F H P H U R L U N T  
 N U N O Q C G A Y T V L N O E  
 X K H U P X I G P H I I D P M  
 E O I D A A R V A B R S L E A  
 C A L L I R H O E N A T Y K Z  
 E A H P I S A P S M Y O R L E  
 R E Q B V P N L A T T M Z W T  
 F T K I R Y B L E S Z Y E M P  
 A S B Z A P T R I B T J N D P  
 N A D M F E M M H K F S A R E  
 G R E F E R E S N S Z O S X C  
 E D H A A H I M A L I A I P  
 T A M C T L E D A D J Y N P P

GANYMEDE

EUROPA

THEBE

METIS

LYSITHEA

LEDA

CALLISTO

AMALTHEA

ELARA

CARME

ANANKE

CALLIRHOE

IO

HIMALIA

PASIPHAE

SINOPE

ADRASTEIA

THEMISTO

Jupiter has 63 known moons.  
 These are the 18 largest in diameter (in order from left to right)

Source: Wikipedia.com

## Printable Sudoku Puzzles – Medium #1

1		8			6	4		
		6		9		8		7
5								
2	6	9	5				8	
			4		9			
	8				2	7	9	1
								5
6		4		7		2		
		1	2			9		3

4		6		2				
	8		4				9	3
3				8	5			2
7		9						8
	5			7			4	
6							7	1
9			2	4				5
2	6				8		7	
				3			1	9

			2	4		6		
9								3
1					3		4	5
5	6			7		1		
		4	8		5	9		
		1		6			5	2
6	9		5					1
4								9
		8		9	6			

			7		9		2	
		9	2	1	6			5
5			8		4			
	6						4	
3	7			4			6	1
		2					5	
			9		7			3
7			3	8	5	2		
	3		4		1			

# KID'S CORNER

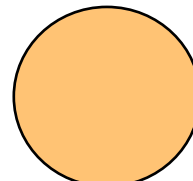
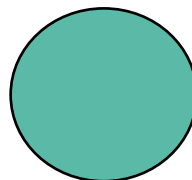
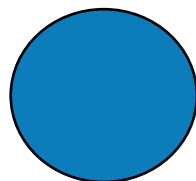
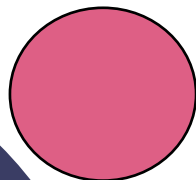
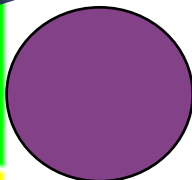
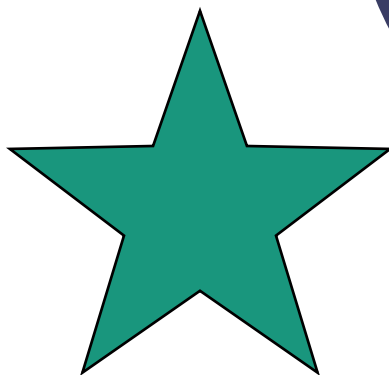



# Census

Every stat tells a story

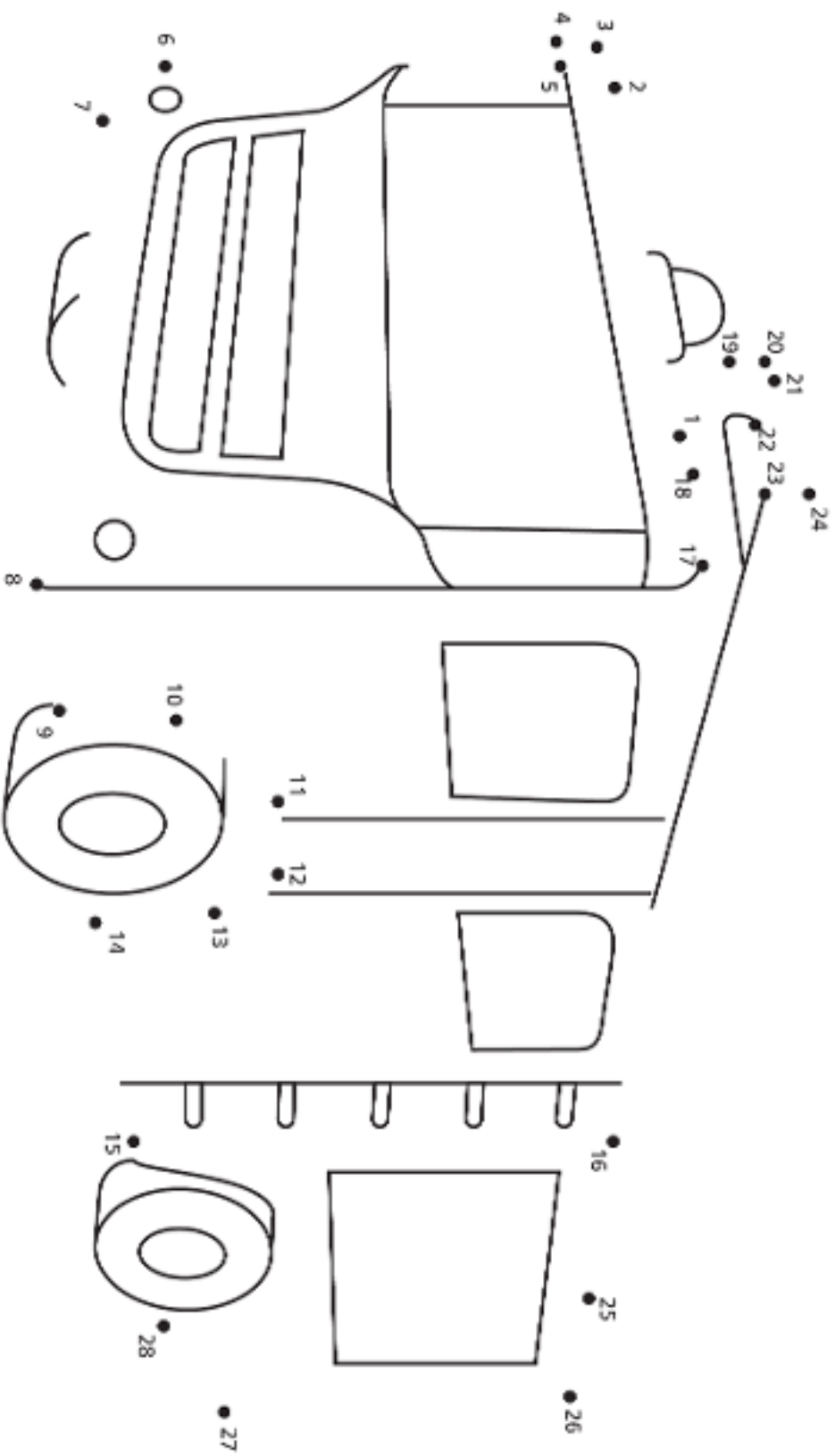

**The Census is on Tuesday 10 August 2021**

When you complete your Census, you're building a better future for all of us. The information you provide helps inform important services for families, like child care, schools, transport and health care.

**For more information**

 [www.census.abs.gov.au](http://www.census.abs.gov.au)

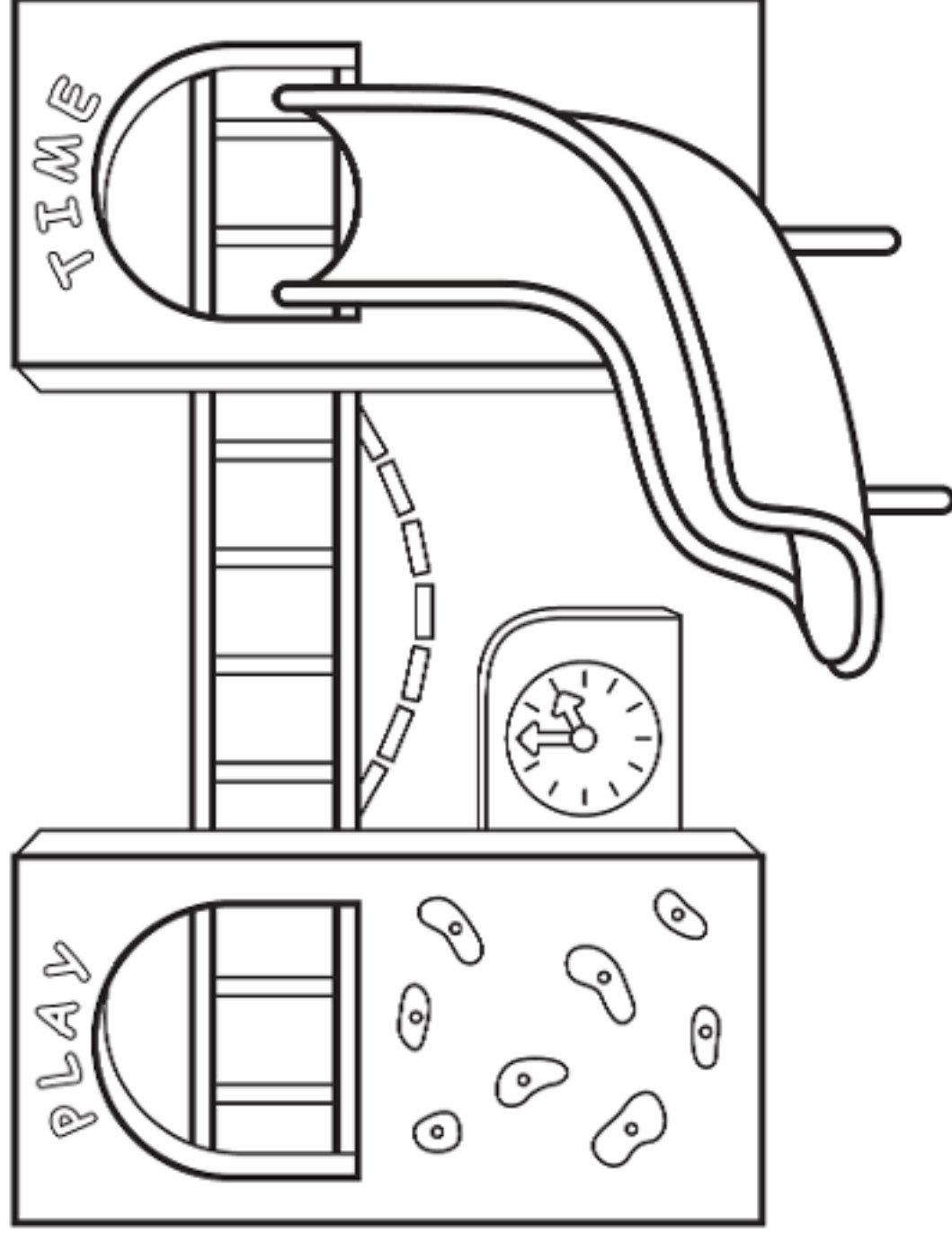

**The Census is on Tuesday 10 August 2021**

When you complete your Census, you're building a better future for all of us. The information you provide helps inform important services for families, like child care, schools, transport and health care.

**For more information**

 [www.census.abs.gov.au](http://www.census.abs.gov.au)

**GASCOYNE  
JUNCTION  
FOOD  
FESTIVAL**

THE JUNCTION

13 AUGUST

**STARGAZING  
IN THE  
JUNCTION**

PAVILION &  
OVAL

14 AUGUST

**JUNCTION  
RACE CLUB  
BUSY BEE**

JRC

14 & 15 AUGUST

**BE  
CONNECTED  
SPOTTING  
SCAMS**

CRC

18 AUGUST

**JUNCTION  
RACES**

JRC

20 - 22 AUGUST



UPCOMING **20**  
**EVENTS** **21**

**BE  
CONNECTED  
ONLINE  
BANKING**

CRC

01 SEPTEMBER

**AUSTRALIA'S  
BIGGEST BBQ**

MT AUGUSTUS

04 SEPTEMBER

**BE  
CONNECTED  
HELPFUL  
APPS**

CRC

16 SEPTEMBER

**RFDS BALL**

PAVILION

18 SEPTEMBER

**VISITOR STOP  
OPENING**

AMPITHEATRE

19 SEPTEMBER

**JUNCTION  
CRAFT  
CLUB**

PAVILION

18 -19 SEPTEMBER

**LANDOR  
RACES**

EAST LYONS  
RACE CLUB

1 -4 OCTOBER

**BE  
CONNECTED  
PROTECT  
FROM SCAMS**

CRC

11 OCTOBER